

Aufbewahrungssystem Tischplatten

Storage System tabletop | Système de rangement plateaux de table |
Sistema di stoccaggio da tavolo

Montageanleitung

assembly instructions | instructions de montage |
istruzioni di montaggio

Ehrenkind

Lieferumfang prüfen

1. Nimm die Einzelteile aus der Verpackung.
2. Prüfe, ob die Lieferung vollständig ist.
3. Prüfe, ob das Produkt, die Einzelteile oder das Zubehör Schäden aufweisen. Ist dies der Fall, benutze das Produkt nicht. Wende dich direkt an uns über das Serviceportal.

- 1 Tischplatte
- 2 Verbindungsschrauben
- 3 Inbusschlüssel



Bitte beachte die Hinweise
in der Montageanleitung!

Checking scope of delivery

1. Take the individual components out of the packaging.
2. Check whether the delivery is complete.
3. Check whether the product, the individual components or accessories are damaged. If this is the case, do not use the product. Contact us directly via our service portal.

- 1 Table top
- 2 Connecting screws
- 3 Allen key

Please note the information
in the assembly instructions!

Vérification du contenu de la livraison

1. Sortez les différentes pièces de l'emballage.
2. Vérifiez si la livraison est complète.
3. Vérifiez si le produit, les pièces détachées ou les accessoires présentent des dommages. Si tel est le cas, n'utilisez pas le produit. Contactez-nous directement via notre portail de services.

- 1 Plateau de table
- 2 Vis d'assemblage
- 3 Clé Allen



Veuillez tenir compte des indications dans les instructions de montage !

Controllo della fornitura

1. Estrarre le singole parti dall'imballaggio.
2. Controllare che la fornitura sia completa.
3. Controllare se il prodotto, le singole parti o gli accessori sono danneggiati. In tale eventualità, non utilizzare il prodotto. Contattaci direttamente tramite il nostro portale di servizi.

- 1 Piano del tavolo
- 2 Viti di collegamento
- 3 Chiave a brugola

Si prega di osservare nelle indicazioni istruzioni di montaggio!

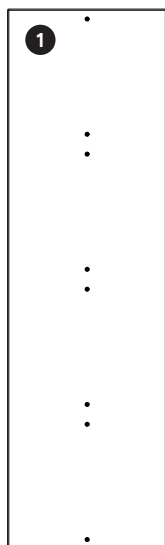

40×136 cm

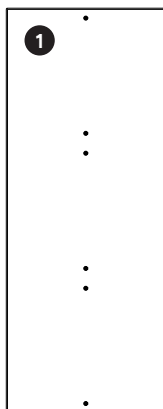

40×102 cm

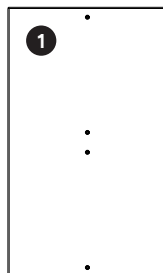

40×68 cm

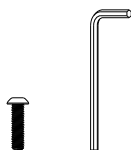

2

3

Nur eine der dargestellten Platten ist Teil des jeweiligen Lieferumfangs!
Anzahl der Schrauben ist abhängig von der Platte:

40×136 cm: 8 Schrauben

40×102 cm: 6 Schrauben

40×68 cm: 4 Schrauben

Only one of the displayed panels is included in the respective delivery!
The number of screws depends on the panel:

40×136 cm: 8 screws

40×102 cm: 6 screws

40×68 cm: 4 screws

Une seule des plaques affichées fait partie de la livraison respective !
Le nombre de vis dépend de la plaque :

40×136 cm: 8 vis

40×102 cm: 6 vis

40×68 cm: 4 vis

Solo una delle piastre mostrate è inclusa nella rispettiva consegna!

Il numero di viti dipende dalla piastra:

40×136 cm: 8 viti

40×102 cm: 6 viti

40×68 cm: 4 viti

Tischplatte montieren
Assembling the tabletop

Monter le plateau de table
Montaggio del piano del tavolo

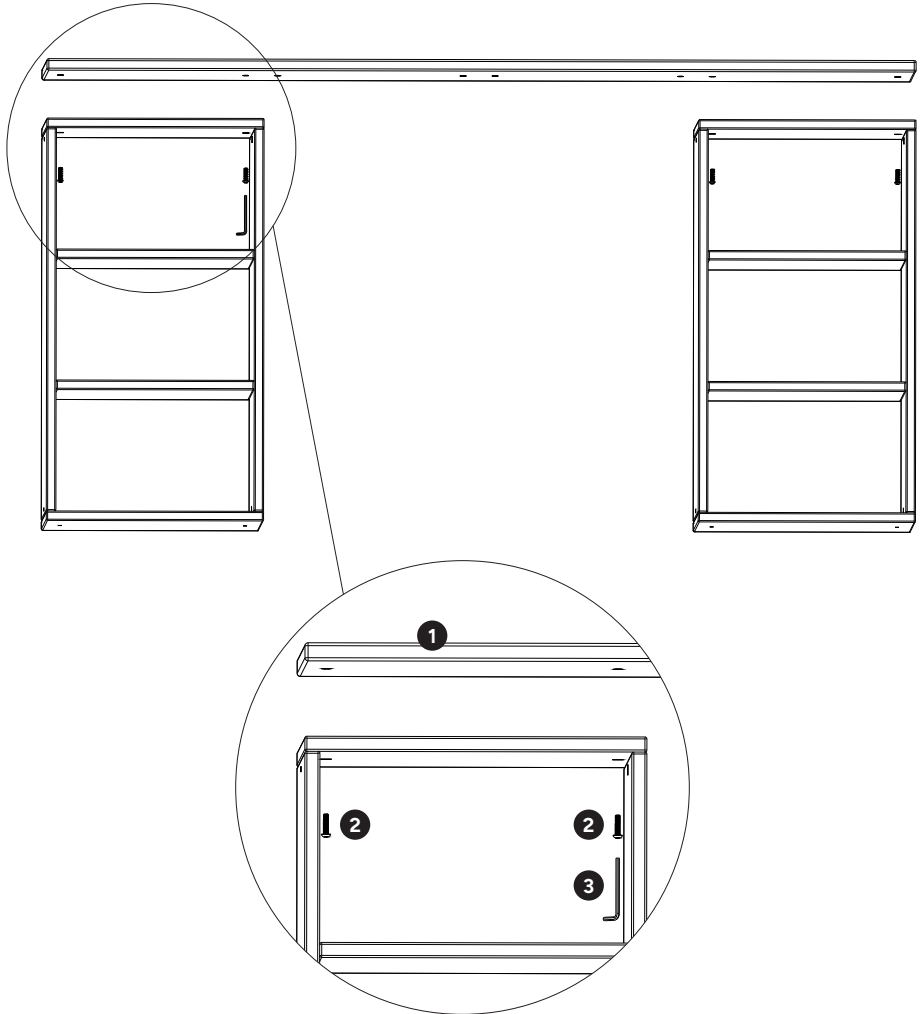

Aufbauvarianten:

Tischplatte 40×136 cm

Assembly options:

tabletop 40×136 cm

Options de montage :

Plateau de table 40×136 cm

Opzioni di montaggio:

Piano del tavolo 40×136 cm

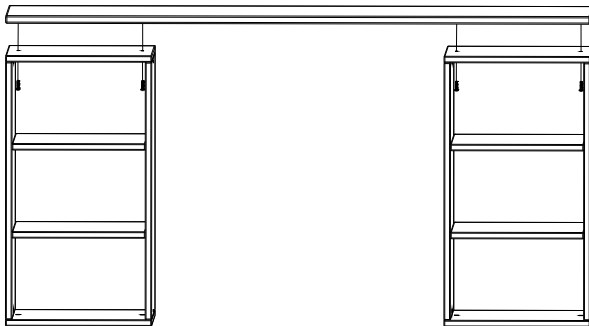
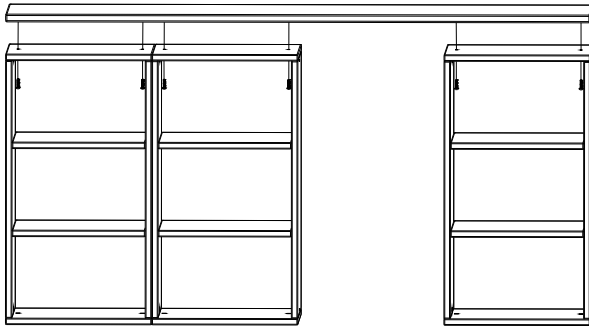
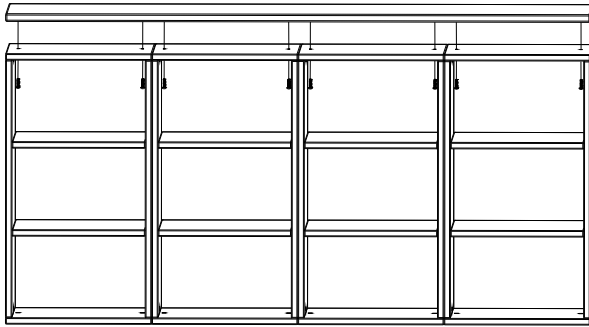

Aufbauvarianten:

Tischplatte 40×102 cm

Assembly options:

tabletop 40×102 cm

Options de montage :

Plateau de table 40×102 cm

Opzioni di montaggio:

Piano del tavolo 40×102 cm

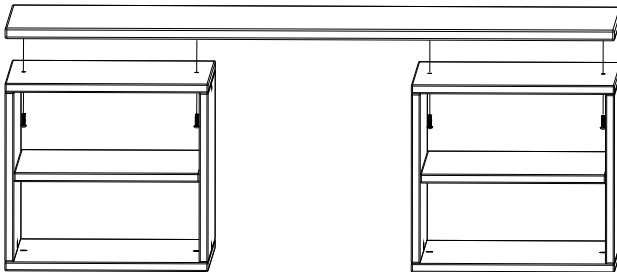
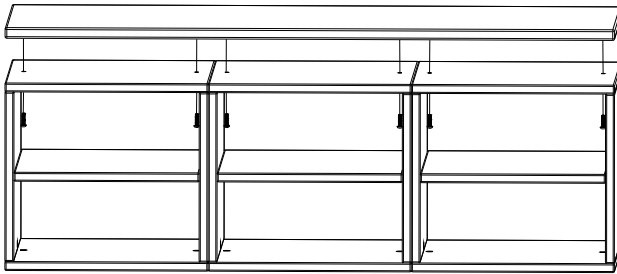

Aufbauvariante:

Tischplatte 40×68 cm

Assembly option:

tabletop 40×68 cm

Variante de montage :

Plateau de table 40×68 cm

Variante di montaggio:

Piano del tavolo 40×68 cm

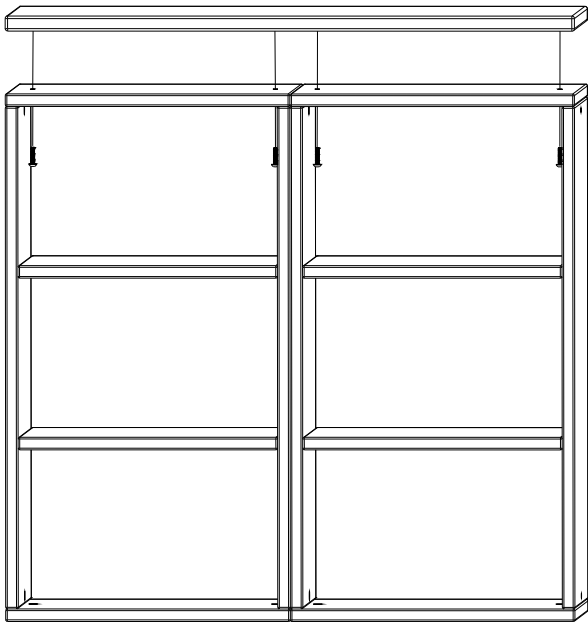

Ehrenkind

Du brauchst Unterstützung?

Besuche unser Serviceportal, scanne einfach den Code mit deinem Smartphone.

Need support?

Visit our service portal, simply scan the code with your smartphone.



Ehrenkind

formbench GmbH
Ginsterweg 3
74523 Schwäbisch Hall